

# DLH-8531

## 3" Adjustable Round Housing For

12V Max.50W MR16 and Max.39W MR16 CMH Lamps

Catalog #		Type
Project		Date
Prepared by		

HALOGEN

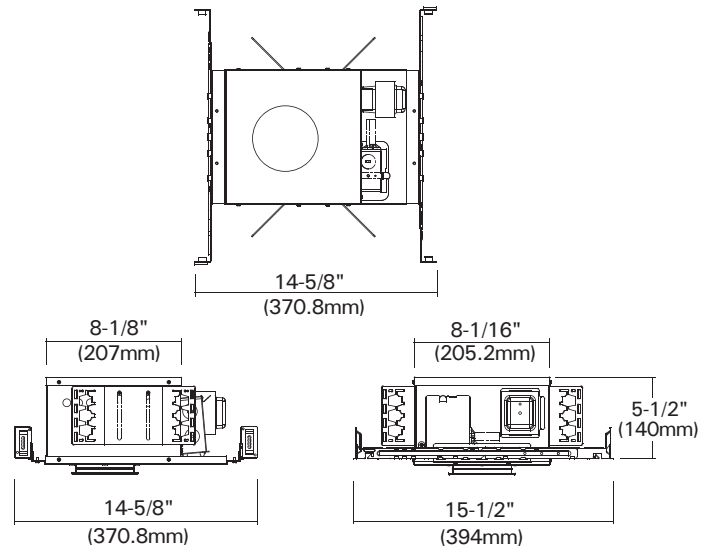
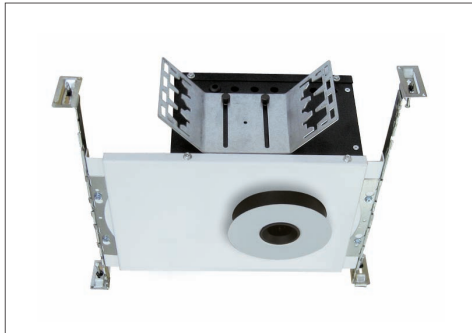

### DESIGN FEATURES

Ceiling Cut-out : 4-3/8"

Lamp, Max, Watt. : 50W MR16 / 39W MR16 CMH

#### ◦ Housing

- Single wall steel housing with black powder coated.
- 5-1/2" height allows use in 2" x 6" joist construction.
- Housing adjusts for ceilings up to 1" thick.

#### ◦ 12V Transformer & CMH Ballast

- -M50 : 50W Magnetic Transformer
- -E50 : 50W Electronic Transformer
- -E20MH : 39W CMH Electronic Ballast
- -E39MH : 39W CMH Electronic Ballast

#### ◦ Junction Box

- Listed for through branch circuit wiring.(Max.8 No 12 AWG 90°C branch circuit conductors. (4 in, 4 out)
- (5)1/2" knockouts with true pry-out slots and (4) knockouts with Romex cable clamp.
- Ground wire provided on J-box.

#### ◦ Mounting Channel Bracket

- Commercial mounting kit provided up to 5" vertical adjustment, which accommodates 1/2" EMT conduit, optional HB-24 or HBC-24 bar hanger or lathing channels for T-bar grid or concealed spline ceiling.

#### ◦ Socket

- GU5.3 Bi-pin lampholder for 12V/MR16
- GX10 lampholder for MR16 CMH

#### ◦ Reflector

- Aluminium spun polished reflector, and available is clear, iridency free haze clear black. Gold or painted gloss white finish.
- Flange; Self-flanged, or die casting flange with painted white or clear chrome finish.

#### ◦ Listing

- cCSA-us Certificated

### Ordering Information

Housing	Transformer/Ballast	Voltage
DLH-8531	-M50 : 50W Magnetic -E50 : 50W Electronic -E20MH : 20W CMH Electronic -E39MH : 39W CMH Electronic	-Blank : 120V -27 : 277V

Example : DLH-8531-M50

# Trims

## 3" Trims For DLH-8531

Catalog #		Type
Project		Date
Prepared by		

HALOGEN

### TMH-324R-ST

**Straight Reflector Cone**  
- 50° cut-off reflector



TMH-324R-ST

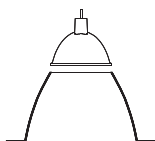

### TMH-337-ST

**Pin Hole**  
- 1-1/4" Pin-hole aperture  
- Recessed deeply concealed lamp  
- Beam spread : FLD 40°

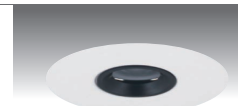

TMH-337-ST

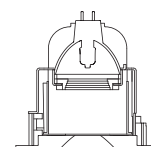

### TMH-324RG-ST

**Shower Lens Trim**  
- 50° cut-off straight reflector



TMH-324RG-ST

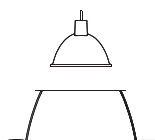

### TMH-3341-ST

**Pin Hole**  
- 1-1/4" Pin-hole aperture  
- Straight deep cone reflector

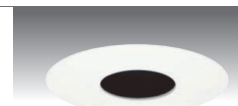

TMH-3341-ST

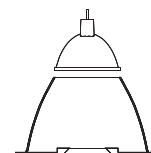

### TMH-309-AJ

**Slotted Wall Wash**  
- 2" Slotted oval aperture  
- Adjustable to 45° with wall wash slope reflector

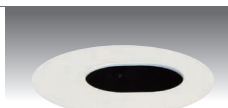

TMH-309-AJ

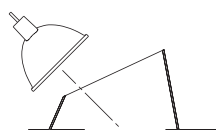

### TMH-3253RG-AJ

**Wall Wash Angle cut Reflector**  
- Adjustable to 45°



TMH-3253RG-AJ

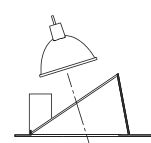

### TMH-334P-AJ

**Pin Hole**  
- 1-1/4" Pin-hole aperture  
- Adjustable to 45° with wall wash slope reflector



TMH-334P-AJ

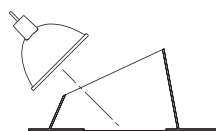

### TMH-325RG-AJ

**Angle cut Wall Wash Reflector**  
- Wet location lens  
- Adjustable to 45°



TMH-325RG-AJ

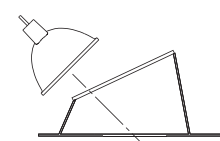

### ORDERING INFORMATION

Choose the catalog / finish codes that best suit your needs and enter it on the appropriate line.

TRIM MODEL	REFLECTOR	TRIM RING	OPTION
	CL :Clear	WH :White	LSL :Linear Spread Lens
	HC :Haze Clear	PB :Polished Brass	HCL :Hex Cell Louver
	CG :Champagne Gold	SF :Self Flange	FC :Frosted Lens
		CF :Custom Flange	

Examples:  
TMH-324R-CL-WH = Straight reflector cone